

YSV12 SERIES



Input: 85-265VAC 50/60Hz
Output Voltage: 5V-36V DC
Rated Power: 12W max

Features

Univeral AC input/ Full range
 Energy efficiency level VI
 Leakage Current: < 0.25mA
 Extremely low leakage current
 Protection: Over load/Over voltage/Short circuit
 Withstand voltage : 3KV
 Life Warranty: 3 years

Application

Telecommunications,
 Security,
 Access Control Systems
 Home Appliances,
 IT
 Motors
 Medicall



■ Dimensions and Installation

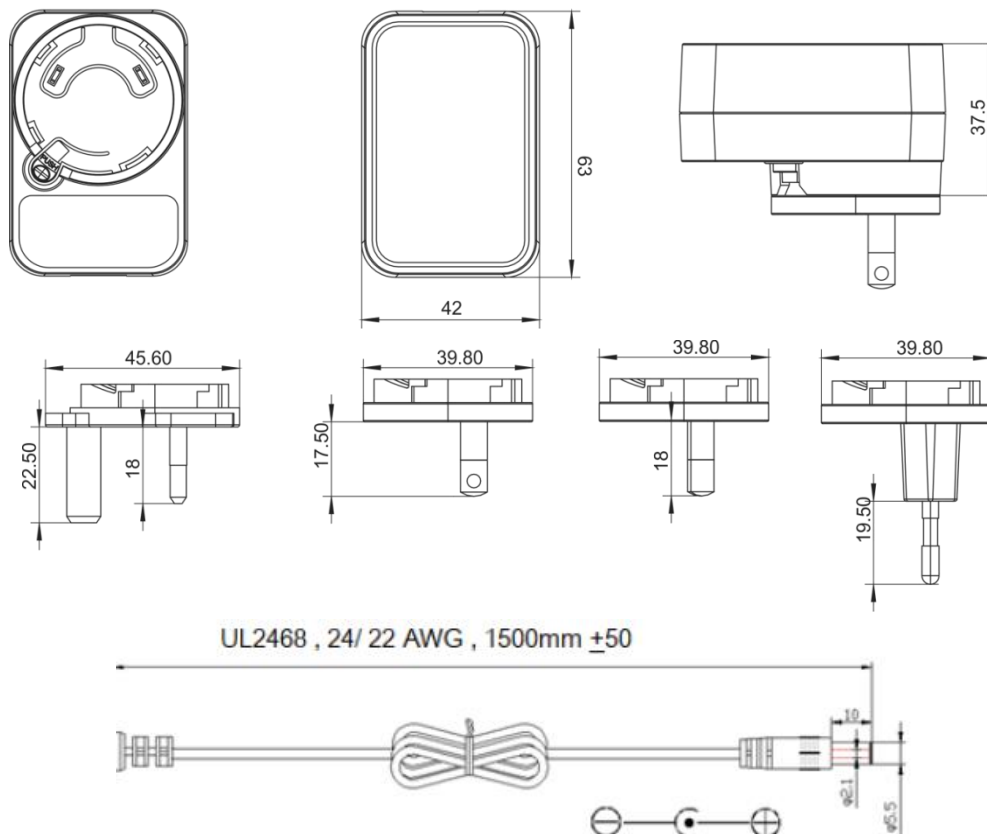

YSV12 SERIES

MODEL DETAIL SPEC.		YSV12-0502000	YSV12-0901330	YSV12-1201000	YSV12-1500800	YSV12-1800670	YSV12-2400500
INPUT	Input Voltage:	85-265VAC					
	Input Frequency:	50/60Hz					
	Inrush Current:	40A/115VAC 60A/230VAC					
	AC Current:	0.5A max.					
	Leakage Current:	< 0.25mA/240VAC					
	Efficiency:	80.5%	84%	84%	85%	85%	85%
OUTPUT	DC Voltage:	5V	9V	12V	15V	18V	24V
	Rated Current:	2A	1.33A	1A	0.8A	0.67A	0.5A
	Rated Power:	10W	12W	12W	12W	12W	12W
	Voltage Tolerance:	±5.0%	±5.0%	±5.0%	±5.0%	±5.0%	±5.0%
	Ripple and Noise:	90mVp-p	100mVp-p	120mVp-p	150mVp-p	180mVp-p	240mVp-p
	Line Regulation:	±3%					
	Load Regulation:	±5%	±5%	±5%	±5%	±5%	±5%
	Setup, Rise, Hold Up time:	500ms, 30ms/120ms 230VAC 1000ms, 30ms/25ms 115VAC at full load					
ENVIRONMENTAL	Operating Temperature:	-20 ~ +60 (Refer to "Derating Curve")					
	Storage Temp:	-40°C ~ 85°C					
	Storage Humidity:	10 ~ 95% RH					
	Working Humidity:	20 ~ 95% RH non-condensing					
PROTECTION	Over Load:	105% -150% rated output power					
		Protection type: Hiccup mode, recovers automatically after fault condition is removed					
	Over Voltage:	105% -130% rated output power					
		Protection type: Shut down o/p voltage, re-power on to recover					
Over Temperature:	N/A						
SAFETY & EMC	Safety Regulations:	UL62368-1, TUV BS EN/EN62368-1, EAC TP TC 004, BSMI CNS14336-1, AS/NZS 62368.1 approved					
	Withstand Voltage:	I/P-O/P:3KVAC I/P-FG:2KVAC O/P-FG:0.5KVAC					
	Isolation Resistance:	I/P-O/P, I/P-FG, O/P-FG:100M Ohms / 500VDC / 25°C/ 70% RH					
	EMC Emission:	Compliance to BS EN/EN55032 (CISPR32), BS EN/EN61204-3 Class B, BS EN/EN61000-3-2,-3, EAC TP TC 020, CNS13438 Class B					
	EMC Immunity:	EN/EN61000-4-2,3,4,5,6,8,11					
OTHER	MTBF:	500Khrs min. MIL-HDBK-217F(25°C)					
	Size:	63*42*37.5 mm					
	Weight:	135g / pc					
	Packaging:	50PCS					

YSV12 SERIES

Deduction curve and temperature

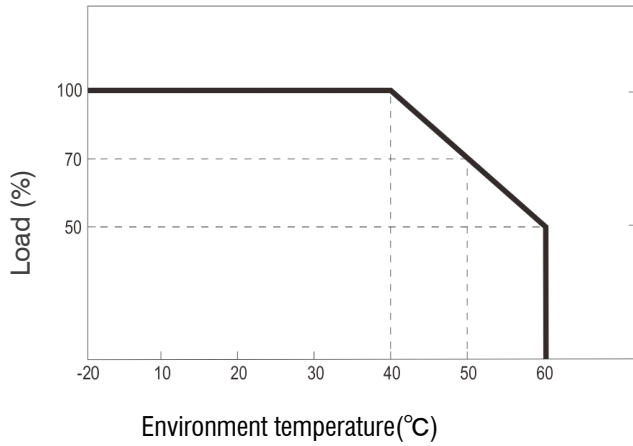

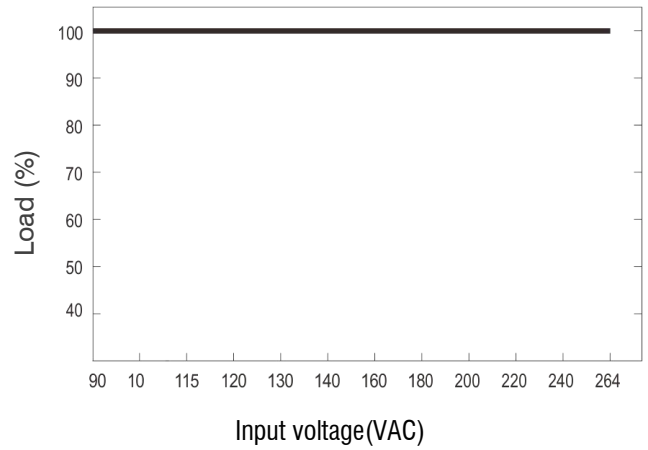

Minus output and input voltage curves











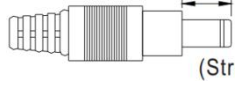
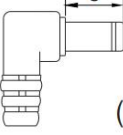

DC output plug

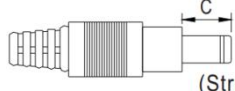
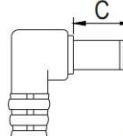
Standard plug :D1M

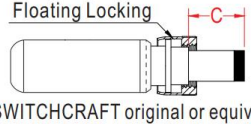

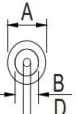
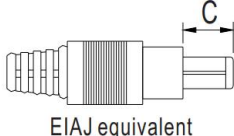
D1M	Pin Assignment
 	 <p>Outside ⊖ ⊕ Inside</p> <p>-V not connected to AC FG(standard) -V connected to AC FG(optional)</p>

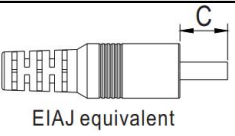
Optional DC plug: (Available in customized cable or quick adapter)

Tuning Fork Style		Type No.	A	B	C	Quick Adapter Accessory	
			OD	ID	L		
   (Straight)	D1I	5.5	2.1	9.5	Available (Current rating: 7.5A max.)		
	D1L	5.5	2.5	9.5			
	D1M	5.5	2.1	11.0			
	 (Right-angled)	D1IR	5.5	2.5		9.5	
		D1JR	5.5	2.1		11.0	
		D1LR	5.5	2.5		9.5	
		D1MR	5.5	2.5		11.0	
Barrel Style		Type No.	A	B	C	Quick Adapter Accessory	
			OD	ID	L		
   (Straight)	D2I	5.5	2.1	9.5	None		
	D2J	5.5	2.1	11.0			
	D2L	5.5	2.5	9.5			
	D2M	5.5	2.1	11.0			
	 (Right-angled)	D2IR	5.5	2.5		9.5	
		D2JR	5.5	2.1		11.0	
		D2LR	5.5	2.5		9.5	
D2MR		5.5	2.5	11.0			
Lock Style		Type No.	A	B	C	Quick Adapter Accessory	
			OD	ID	L		
   Floating Locking SWITCHCRAFT original or equivalent	D2S(S761K)	5.53	2.03	12.06	None		
	D2K(761K)	5.53	2.54	12.06			
	D2C(S760K)	5.53	2.03	9.52			
	D2D(760K)	5.53	2.54	9.52			
Center Pin Style		Type No.	A	B	C	D	Quick Adapter Accessory
			OD	ID	L	Center Pin	
   EIAJ equivalent	D4A	5.5	3.4	11.0	1.0	Available (Current rating: 7.5A max.)	
	D4B	6.5	4.4	11.0	1.4		
	D4C	7.4	5.1	11.0	0.6		
Min. Pin Style		Type No.	A	B	C	Quick Adapter Accessory	
			OD	ID	L		
   EIAJ equivalent	D3A	2.35	0.7	11.0	Available (Current rating: 5A max.)		
	D3B	4.0	1.7	11.0			
	D3C	4.75	1.7	11.0			

YSV12 SERIES

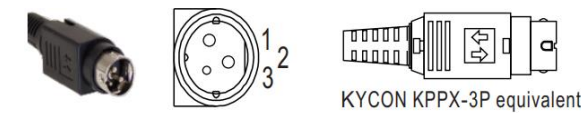
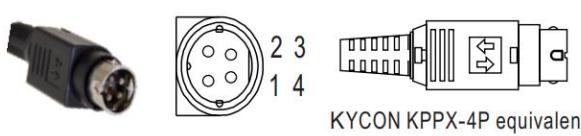
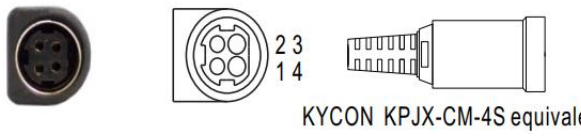
Optional DC plug: (Available in customized cable or quick adapter)

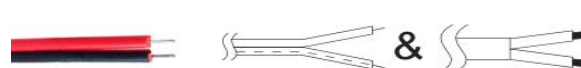
Min.Din 3Pin with Lock (male)	Type No.	Pin Assignment		Quick Adapter Accessory
		PIN No.	Output	
 <p>KYCON KPPX-3P equivalent</p>	M6B	1	+Vo	Available (Current rating: 7.5A max.)
		2	-Vo	
		3	+Vo	
Min.Din 4Pin with Lock (male)	Type No.	Pin Assignment		Available (Current rating: 7.5A max.)
 <p>KYCON KPPX-4P equivalent</p>	M7B	PIN No.	Output	
		1	+Vo	
		2	-Vo	
		3	-Vo	
		4	+Vo	
Min.Din 4Pin with Lock (female)	Type No.	Pin Assignment		None
 <p>KYCON KPJX-CM-4S equivalent</p>	M7BF	PIN No.	Output	
		1	+Vo	
		2	-Vo	
		3	-Vo	
		4	+Vo	
DIN 5Pin (male)	Type No.	Pin Assignment		Available (Current rating: 7.5A max.)
	M1B	PIN No.	Output	
		1	-Vo	
		2	-Vo	
		3	+Vo	
		4	-Vo	
		5	+Vo	
Stripped and tinned leads	Type No.	Pin Assignment		None
	by customer	1	+Vo	
		2	-Vo	